

AHB-11-AR16



For over 20 ft. (6 meter) applications factories, foundries, machines shops, warehouse, and large retail stores.

GENERAL SPECIFICATION

- UL and CUL listed for damp locations
- Superior heavy duty die cast aluminum construction with white powder coating finish
- Mogul base socket-E39 standard, UL approved
- Comes with a hook for easy mounting
- Reflector comes in 16 inches acrylic reflector
- Ideal for HPS and MH 250 Watts Max

DIMENSIONS

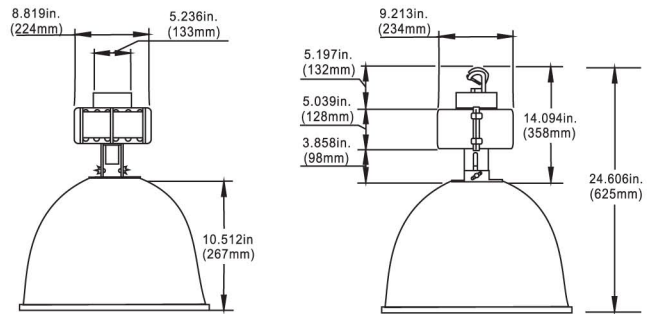

LINE DRAWING

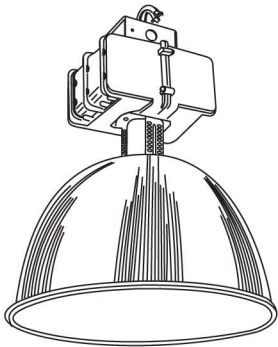

ASSEMBLY PARTS

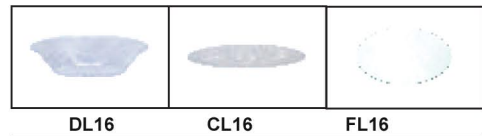

ITEM NO.	LAMP	VOLTS	BALLAST
AHB-11-AR16-250HPS	HPS250W/ED18/E-39	QUAD	HX-HPF
AHB-11-AR16-250MH	MH250W/ED28/E-39	QUAD	HX-HPF